

政鈺機械股份有限公司

GMA MACHINERY ENTERPRISE CO., LTD.

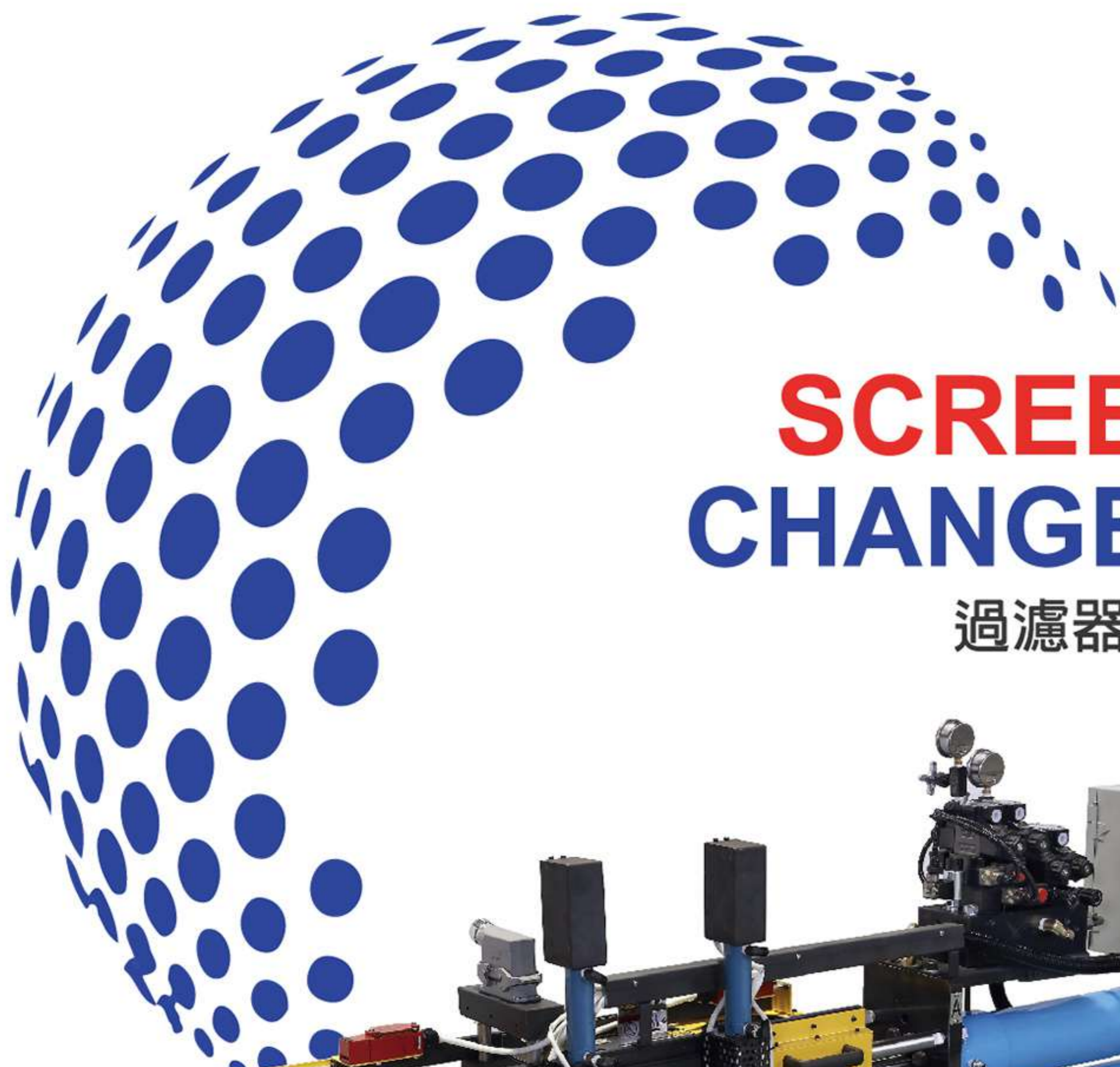

# SCREEN CHANGER

過濾器系列

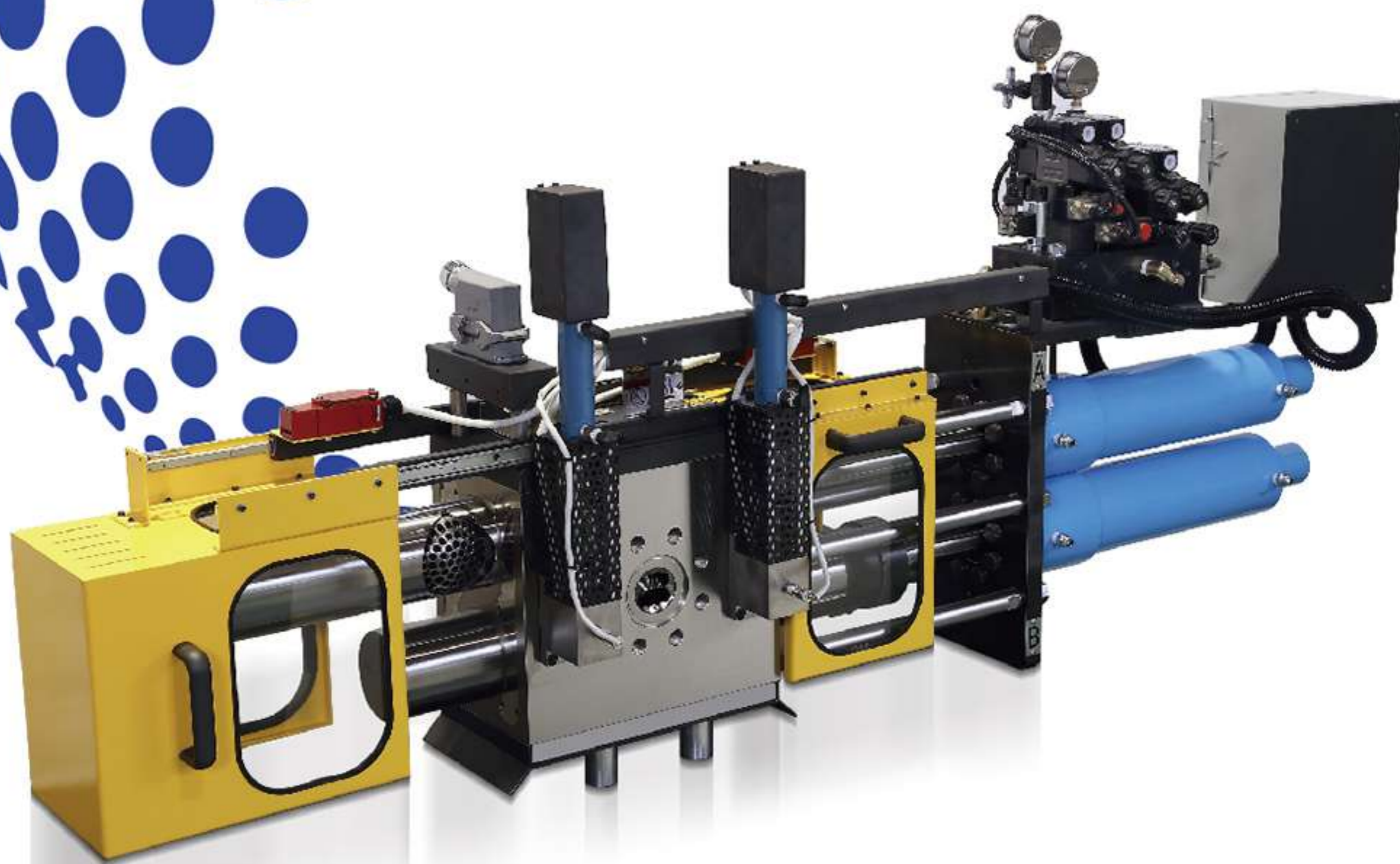

# 柱式四孔過濾器 Pillar Screen Changer Series



## 逆洗式濾網

- 換網無斷料免停機
- 換網時低壓差生產，過程穩定不間斷
- 換網、逆洗時還保有 75 % 過濾面積
- 安全護蓋設計，提高操作人員的安全性
- 全自動逆洗和排氣功能可減少換網所產生的廢料消耗，減少操作人員負擔，有效降低成本，
- 高耐磨、高耐壓、高精度的濾網設計，提供過濾的有效面積和過濾的質量

## Back-Flush

- Interruption free filter replacement.
- Low pressure difference for stable and continuous production during filter replacement.
- Maintain 75% filtering area during filter replacement and backwash.
- Safety cover design improves operator safety.
- Automatic backwash and exhaust function for cutting filter replacement loss, operating requirements and scrap reduction.
- High wear-resistance, high pressure resistance, high-precision filter design provides effective filtering area and filter quality.

運用領域：常見於回收料、製粒、打包帶、薄膜  
Application : suitable for recycle, granulation, packing tape and film.



生產：四個過濾網生產

Normal operation : four screen cavities in the process.



逆洗：當濾網上污染的累積達到設定的壓力差時( $\Delta p$ )，軸心可自動移動至逆洗位置，將汙染排出後軸心再移至生產位置

Back-flush : when the pressure difference ( $\Delta p$ ) reach the setting value, the shaft will move for starting back flush, exhaust polymer then move back to the original position.



換網：換網時，軸心上過濾腔移至過濾器外，即可換下髒的網目，裝上新的網目，再將軸心移至生產位置，換網過程中，仍保有三個過濾腔在過濾

Screen change : the shaft move out the body for operator replaces the mesh, keep three screen cavities in the process.

適用原料：適用多數熱融塑膠

Materials : most polymer.

Model	No 50	No 65
Inlet dia.	Ø 50 mm	Ø 65 mm
Filter dia.	Ø 96 mm	Ø 125 mm
Total watt	2 heating zone 1200W*6 pcs heaters Total 7200 W	2 heating zone 2500W*6 pcs heaters Total 15000 W
Capacity/ PP	250 ~ 700 KG	600 ~ 1300 KG

# 平板式過濾器

## Slide Series



### 油壓平板式濾網

- 液壓控制，操作簡易
- 可選購護蓋式配件，以提高操作安全性

生產：一個過濾網生產

換網：需停機

適用原料：適用多數熱融塑膠

適用領域：板材、薄膜等押出產品

### Hydraulic Slide Plate

- Hydraulic system, easy for operation.
- Optional guard cover to provide highest safety operation.

Normal operation : one screen cavity in the process.

Screen change : need to stop.

Materials : most polymer.

Application : for extrusion products such as sheet and films.

### 超快速平板式濾網

- 流道順暢，少有原料滯留，易清潔
- 換網免停機、換網氣泡少
- 液壓控制，配有蓄壓裝置，操作簡易
- 蜂巢板移動快速可連續式生產

生產：一個過濾網生產

換網：短暫無過濾面積

適用原料：適用多數熱融塑膠

適用領域：光學製品、板材、薄膜等押出產品

### Non-stop Slide Plate

- Streamline and smooth channel for easy clean and little polymer stagnation.
- Interruption free and few bubbles caused by filter replacement.
- Hydraulic system with nitrogen accumulator for easy and fast operation.
- Fast slide plate movement for non-stop production.

Normal operation : one screen cavity in the process.

Screen change : no screen cavity in the process.

Materials : most polymer.

Application : for extrusion products such as optical, sheet and films.

Model	No 35	No 45	No 75	No 100	No 120	No 150
Inlet dia.	Ø 35 mm	Ø 45 mm	Ø 75 mm	Ø 100 mm	Ø 120 mm	Ø 150 mm
Filter dia.	Ø 48 mm	Ø 60 mm	Ø 113 mm	Ø 103 mm	Ø 150 mm	Ø 200 mm
Each hole dia.	Ø 4 mm	Ø 4 ~ 5 mm	Ø 4.5 ~ 5 mm	Ø 4 ~ 5.5 mm	Ø 4 ~ 5.5 mm	Ø 4.5 ~ 6 mm
Total watt	3 heating zone 1 <sup>st</sup> zone 3600 W 2 <sup>nd</sup> zone 1260 W 3 <sup>rd</sup> Zone 960 W	3 heating zone 1 <sup>st</sup> zone 3600 W 2 <sup>nd</sup> zone 1260 W 3 <sup>rd</sup> Zone 960 W	3 heating zone 1 <sup>st</sup> zone 3600 W 2 <sup>nd</sup> zone 1260 W 3 <sup>rd</sup> Zone 960 W	3 heating zone 1 <sup>st</sup> zone 7600 W 2 <sup>nd</sup> zone 2000 W 3 <sup>rd</sup> Zone 2000 W	3 heating zone 1 <sup>st</sup> zone 7600 W 2 <sup>nd</sup> zone 2000 W 3 <sup>rd</sup> Zone 2000 W	3 heating zone 1 <sup>st</sup> zone 10150 W 2 <sup>nd</sup> zone 2600 W 3 <sup>rd</sup> Zone 2060 W
Capacity / PP	25 ~ 70 KG	55 ~ 135 KG	125 ~ 310 KG	125 ~ 310 KG	270 ~ 650 KG	540 ~ 1350 KG

# 平板式免停機過濾器

## Slide Series



### 平板雙軸濾網

- 生產過程可連續不間斷
- 換網無斷料免停機
- 液壓控制，操作簡易
- 可選購護蓋式配件，以提高操作安全性

### Dual Slide Plates

- Continuous production process.
- Interruption free filter replacement.
- Hydraulic system is driven by solenoid valve for easy operation.
- Optional guard cover to provide highest safety operation.

適用原料：適用多數熱融塑膠

適用領域：板材類產品

Materials : most polymer.

Application : suitable for sheet products.

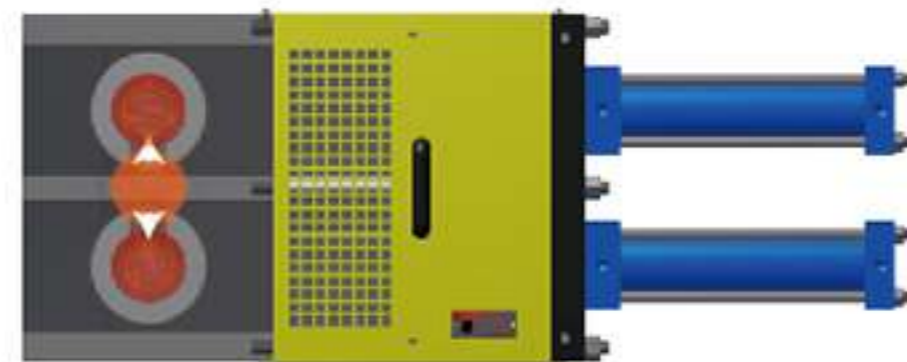

生產：兩個過濾網生產

Normal operation : two screen cavities in the process.

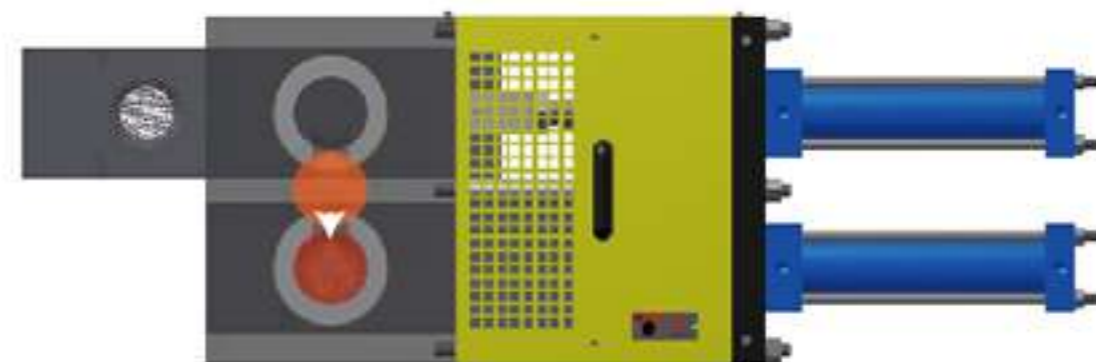

換網：蜂巢板過濾腔移至過濾器外，仍保有一個過濾腔在過濾(50%過濾面積)，即可換下使用過的網目，裝上新的網目，再將蜂巢板移至生產位置

Screen change : ready to replace the plate, the shaft move out the body for operator replaces the plate, keep 50% capacity.

Model	No 60	No 80	No 100	No 120
Inlet dia.	Ø 60 mm	Ø 80 mm	Ø 100 mm	Ø 120 mm
Filter dia.	Ø 66 mm	Ø 90 mm	Ø 110 mm	Ø 132 mm
Each hole dia.	Ø 4.5 mm	Ø 5 mm	Ø 5.5 mm	Ø 5.5 mm
Total watt	2 heating zone 1100W*4 pcs heaters 1100W*4 pcs heaters Total 8800 W	2 heating zone 1300W*4 pcs heaters 1300W*4 pcs heaters Total 10400 W	2 heating zone 1860W*4 pcs heaters 1860W*4 pcs heaters Total 14880 W	2 heating zone 2100W*4 pcs heaters Total 16800W
Capacity / PP	100 ~ 270 KG	200 ~ 500 KG	270 ~ 670 KG	700 ~ 1200 KG

# 柱式免停機過濾器 Pillar Screen Changer Series

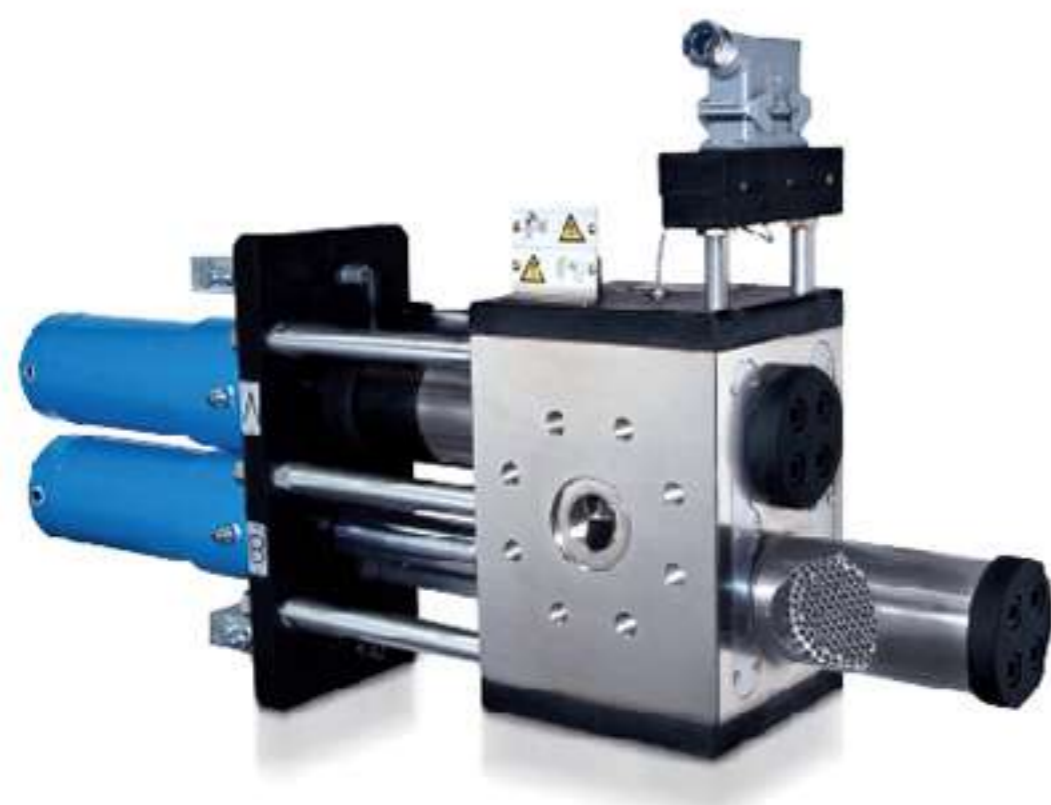

## 軸心式雙軸濾網

- 生產過程連續不間斷，特殊設計空氣不易進入生產流程
- 換網無斷料免停機
- 液壓控制，操作簡易，可選配電控操作
- 可搭配全自動排氣裝置
- 可選配護蓋式配件，以提高操作安全性

## Dual Piston

- Continuous production process, air does not enter the production process.
- Interruption free by filter replacement.
- Hydraulic system is driven by solenoid valve for easy operation. Optional auto-venting system.
- Can be equipped with a fully automatic exhaust.
- Optional guard cover to provide highest safety operation.

適用原料：適用多數熱融塑膠

Materials : most polymer.



生產：兩個過濾網生產

Normal operation : two screen cavities in the process.



換網：軸心上過濾腔移至過濾器外，此時仍保有一個過濾腔在過濾(50%過濾面積)，換下已使用過的網目並裝上新的網目，再將軸心移至生產位置

Screen change : Ready to replace the mesh, the shaft move out the body for operator replaces the mesh, keep 50% capacity.

適用領域：光學製品、板材、薄膜等產品

Application : suitable for optical, sheet, film and other products.

Model	No 36	No. 42	No 50	No 65	No 80	No 100
Inlet dia.	Ø 36 mm	Ø 42 mm	Ø 50 mm	Ø 65 mm	Ø 80 mm	Ø 100 mm
Filter dia.	Ø 46 mm	Ø 76 mm	Ø 96 mm	Ø 125 mm	Ø 160 mm	Ø 176 mm
Each hole dia.	Ø 4 mm	Ø 4 mm	Ø 5 mm	Ø 5 mm	Ø 6 mm	Ø 7 mm
Total watt	1 heating zone 180W*6 pcs heaters Total 1080 W	1 heating zone 1200W*6 pcs heaters Total 7200 W	1 heating zone 1200W*6 pcs heaters Total 7200 W	1 heating zone 1120W*6 pcs heaters Total 6720 W	2 heating zone 1200W*12 pcs heaters Total 14400 W	2 heating zone 1480W*12 pcs heaters Total 17760 W
Capacity / PP	25 ~ 60 KG	60 ~ 250 KG	160 ~ 350 KG	300 ~ 700 KG	600 ~ 1100 KG	700 ~ 1500 KG

# 圓筒型免停機過濾機

## Pillar Screen Changer Series



### 大面積雙軸濾網

- 生產過程連續不間斷
- 特殊排氣設計，空氣不會進入生產流程
- 液壓控制，操作簡易，可選配電控操作
- 可搭配全自動排氣裝置
- 過濾面積可比一般雙軸濾網多出約2~5倍
- 可選購護蓋式配件，以提高操作安全性

### Piston Filters with Large Filtration Area

- Continuous production process.
- Special venting design that no air enter the process during screen changing.
- Hydraulic system is driven by solenoid valve for easy operation. Optional auto-venting system. Can be equipped with a fully automatic exhaust.
- Can be equipped with a fully automatic exhaust.
- The filter area is about 2~5 times larger than the Dual Piston.
- Optional guard cover to provide highest safety operation.

適用原料：適用多數熱融塑膠

Materials : most polymer.

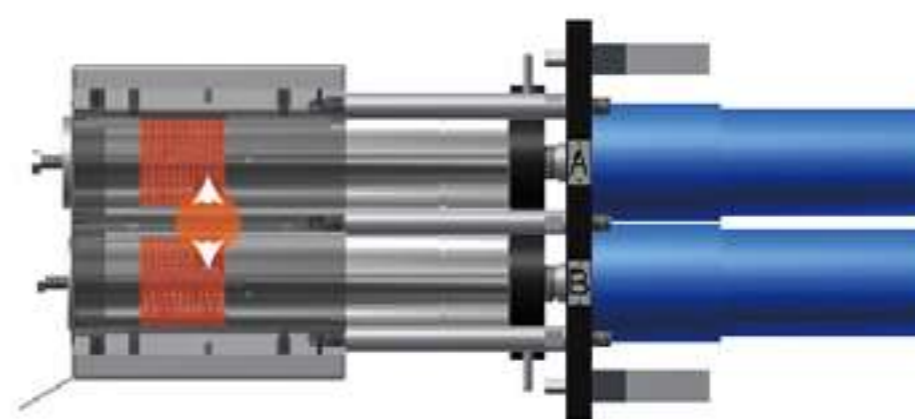

生產：正常情況下兩個過濾網生產

Normal operation : two screen cavities in the process.



換網：軸心上過濾腔移至過濾器外，此時仍保有一個過濾腔在過濾(50%過濾面積)，換下已使用過的網目並裝上新的網目，再將軸心移至生產位置

Screen change : ready to replace the mesh, the shaft move out the body for operator replaces the mesh, keep 50% capacity.

適用領域：製粒、板材、薄膜等產品

Application : suitable for granulation, sheet, film and other products.

Model	No 50	No 250
Inlet dia.	324*100 mm	575*208 mm
Filter dia.	3140*2 cm <sup>2</sup>	11752*2 cm <sup>2</sup>
Total watt	1 heating zone 1800W*6 pcs heaters Total 10800 W	2 heating zone 2340W*6 pcs heaters Total 29480 W
Capacity/ PP	800 ~ 1600 KG	1000 ~ 3900 KG

# 槓桿式過濾器

## Lever Type Screen Changer



### 槓桿式濾網

- 手動更換蜂巢，操作方便
- 無油壓系統，可節省能源
- 頻繁更換物料或顏色時，清潔方便
- 換網過程無過濾面積，需停機換網

### Manual With Lever Gear

- Easy operation with lever gear.
- Energy saving without driven system.
- Easy to clean when changing materials or colors frequently.
- Machine shutdown before filter replacement.

適用原料：適用多數熱融塑膠

適用領域：押板機、吹袋機、實驗機

Materials : most polymer.

Application : usually applied on sheet line, blow line and lab machine.



生產：一個過濾網生產

Normal operation : one screen cavity in the process.



換網：由手動操作一組齒輪機構驅動滑板，使備用過濾腔移至生產位置，即可換下原本於生產位置上使用過的網目，裝上新的網目

Replace mesh : gear drives the slide plate manually, the spare filter will move into chamber, then replacing the mesh.

Model	No 25	No 35	No 45	No 50
Inlet dia.	Ø 25 mm	Ø 35 mm	Ø 45 mm	Ø 50 mm
Filter dia.	Ø 51 mm	Ø 51 mm	Ø 51 mm	Ø 61 mm
Each hole dia.	Ø 3.5 mm	Ø 3.5 mm	Ø 4 mm	Ø 4 mm
Capacity/ PP	25 KG	40 KG	55 KG	65 KG

# 自潔長效型過濾器 Self-cleaning Screen Changer



## 自潔長效型濾網

- 換網無斷料免停機
- 過濾面積大，可使用較高網目數
- 手動換網，免油壓系統，操作方便

## Self-cleaning Screen Changer

- Interruption free filter replacement.
- Large filtering area, applicable with a larger mesh count.
- Manual back wash. Energy saving without driven system.

適用原料：適用多數熱融塑膠

適用領域：板材、淋膜、薄膜

Materials : most polymer.

Application : usually applied on sheet, lamination and film line.

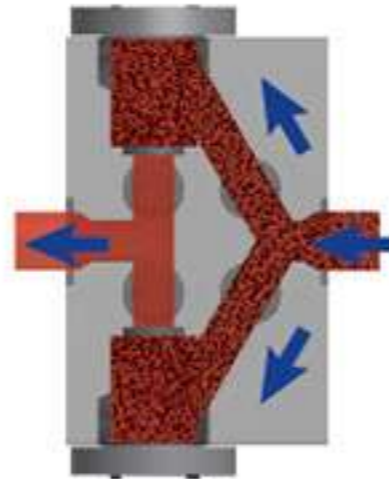

生產：兩個過濾網生產  
Normal operation :  
two screen candles in the process.

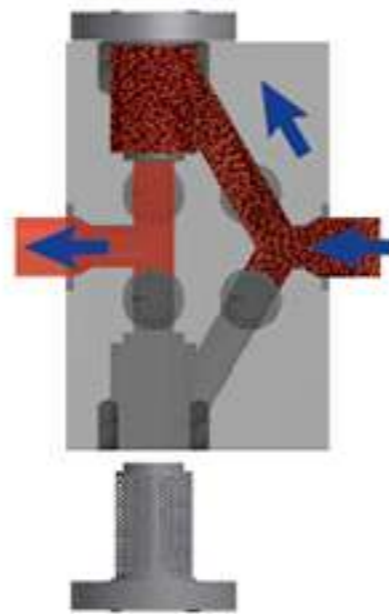

換網：換網時，軸心上過濾腔移至過濾器外，即可換下使用過的網目，裝上新的網目，再將軸心移至生產位置，換網過程中，仍保有一個過濾腔在過濾  
Replace mesh : turn off one candle, take off fixed bolts then replace mesh, keep 50% capacity.

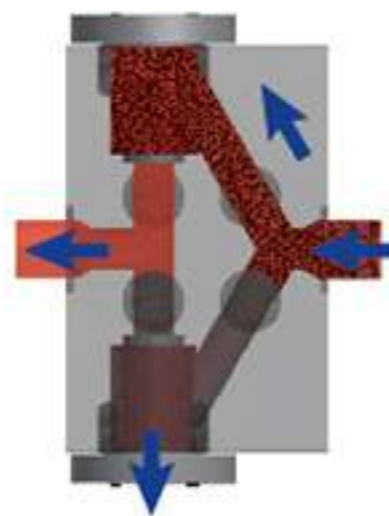

逆洗之料排出位置  
Back-flush position

逆洗：當濾網上污染物累積達到設定的壓力差時( $\Delta p$ )，軸心可調整至逆洗位置，將汙染排出後軸心再移至生產位置，此過程無需停機生產

Continuous back-flush process : when the pressure difference ( $\Delta p$ ) reach the setting value, turn the shaft and start to back flush, exhaust the polymer and air, the turn back to the original position.

Model	No 38	No 70	No 80
Inlet dia.	Ø 38 mm	Ø 70 mm	Ø 80 mm
Filter dia.	173*87 mm	230*114 mm	340*145 mm
Each hole dia.	1418 cm <sup>2</sup>	2508 cm <sup>2</sup>	4785 cm <sup>2</sup>
Total watt	2000W*2 pcs heaters Total 4000 W	3300W*2 pcs heaters Total 6600 W	5250W*2 pcs heaters Total 10500 W
Capacity/ PP	50 ~ 100 KG	150 ~ 250 KG	230 ~ 500 KG



## 調壓式淋膜過濾器 Candle Type Screen Changer

### 調壓式淋膜濾網

- 機構設計緊密，可使用較高網目數，延長過濾時間
- 手動換網，免油壓系統
- 可於生產時進行調壓控制以增加螺桿內的混煉效果

### Candle Type Screen Changer

- Compact mechanical design for higher mesh count to extend filter time.
- Manual network change, no hydraulic system.
- Adjustable pressure control during production to increase the effect of mixing in the screw.

適用領域：淋膜及薄膜產品

Application : applied on Lamination and film line.

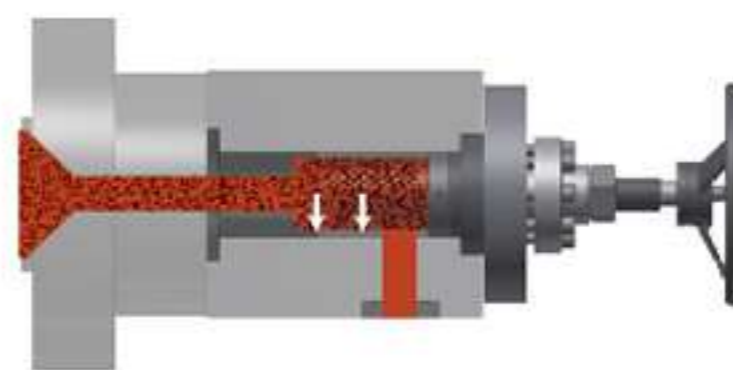

生產：一個過濾網生產

Normal operation : one screen candle in the process.

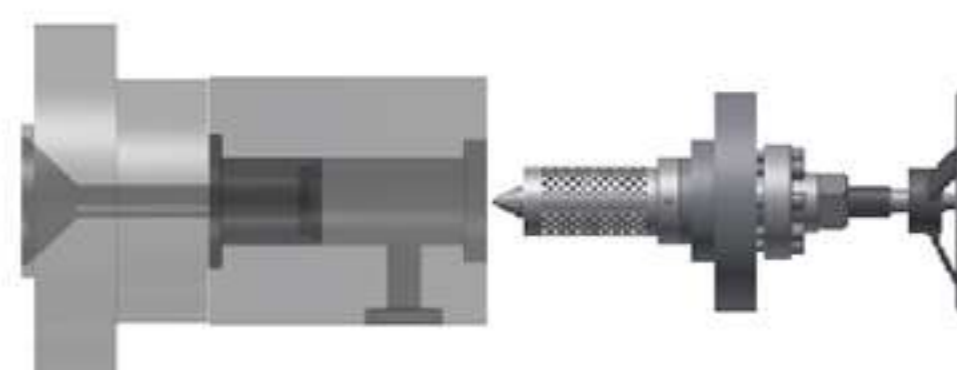

換網：將過濾腔外固定螺絲拆下，即可取出欲更換的網目，裝上新的網目

Replace mesh : take off the fixed bolts, take out the shaft for replacing mesh.

## 過濾配件 Filter Accessories



### 節能板

- 95%的過濾面積可有效使用
- 可延長濾網的壽命
- 減少壓力的損失

### Effective Plates

- 95% of the filter area can be used effectively.
- Extend the life of the filter.
- Reduce the loss of pressure.

### 蜂巢

- 針對網目的固定做優化設計
- 通過對高分子進行流變測試，使整個過濾區域的分佈優化有極佳的成效
- 專為光學產品特製蜂巢，原料不易滯留於孔內

### Breaker Plates

- keeping the mesh fixed well on breaker.
- Distribution optimization of the entire filter area by rheological testing of the polymer.
- Highly polish breaker hole for less polymer stagnation.

# 一體化設計 Design

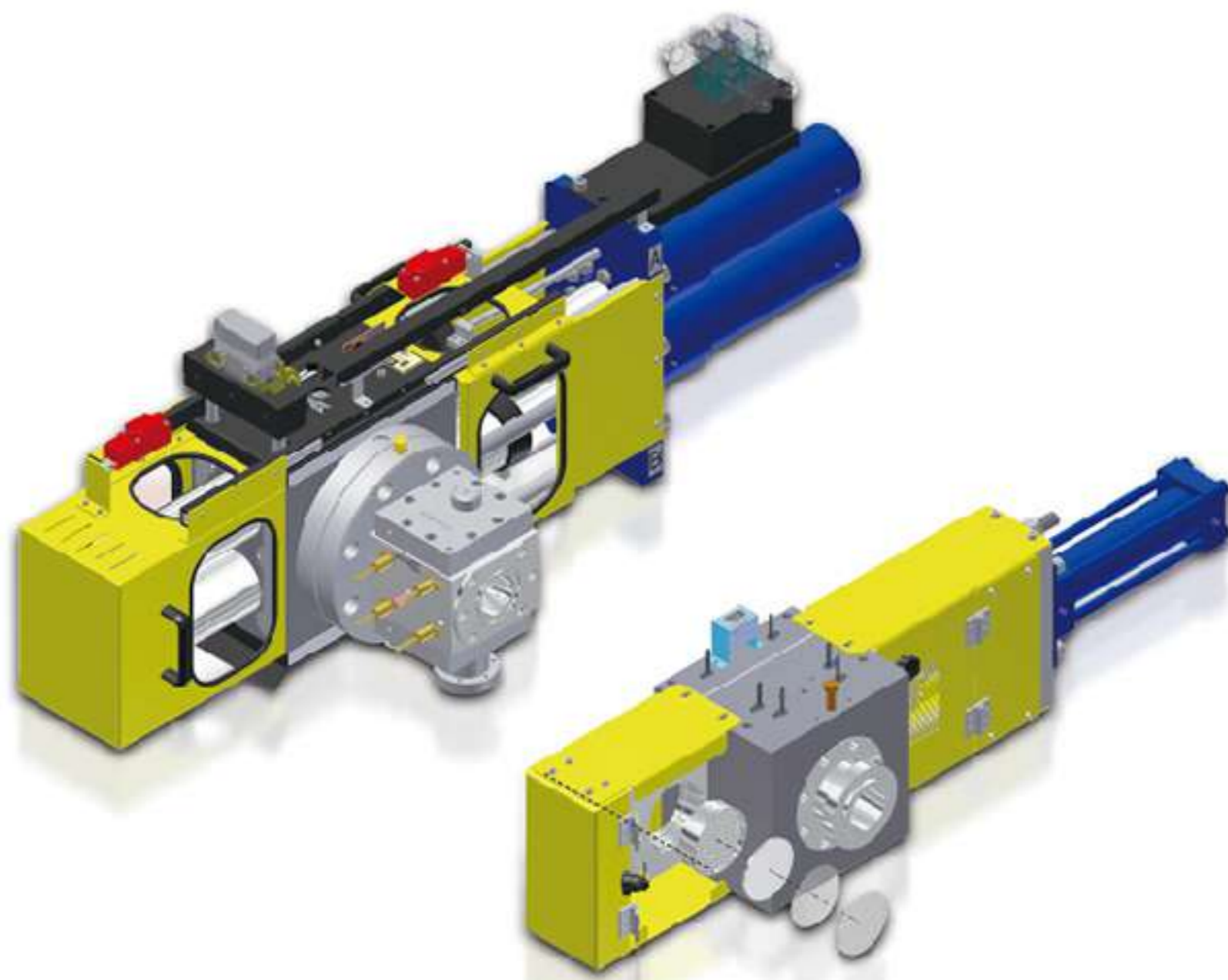

## 工藝優化

流道優化的一體設計，容易維護的特性，專為塑料押出機客戶設計。在使用齒輪泵後，過濾網能做在高壓狀況下通過最短流道來進行高精度過濾效能。

優化設計下，在相同轉速下能減少停留時間而降低回流阻力也能提高生產效率及減少能耗。

## Process Optimization

Integrated design of flow path optimization, easy to maintain features. Designed for plastic extrusion machine customers. Using a gear pump. After that, the filter can do the shortest flow under high pressure conditions. The road is used for high-precision filtration performance. Optimized design, can reduce the stop at the same speed. Time and reduced backflow resistance can also increase production efficiency and reduce energy consumption.

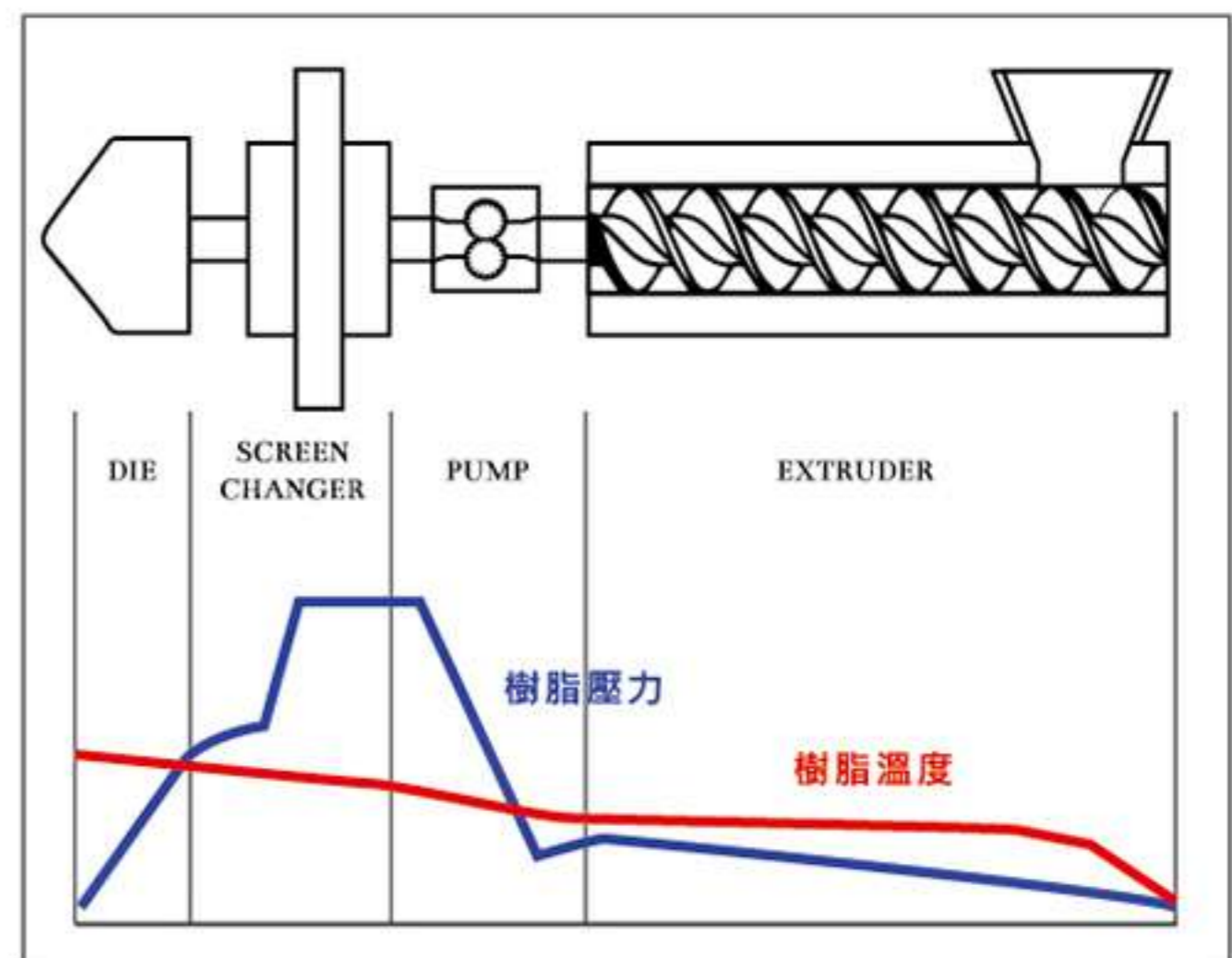
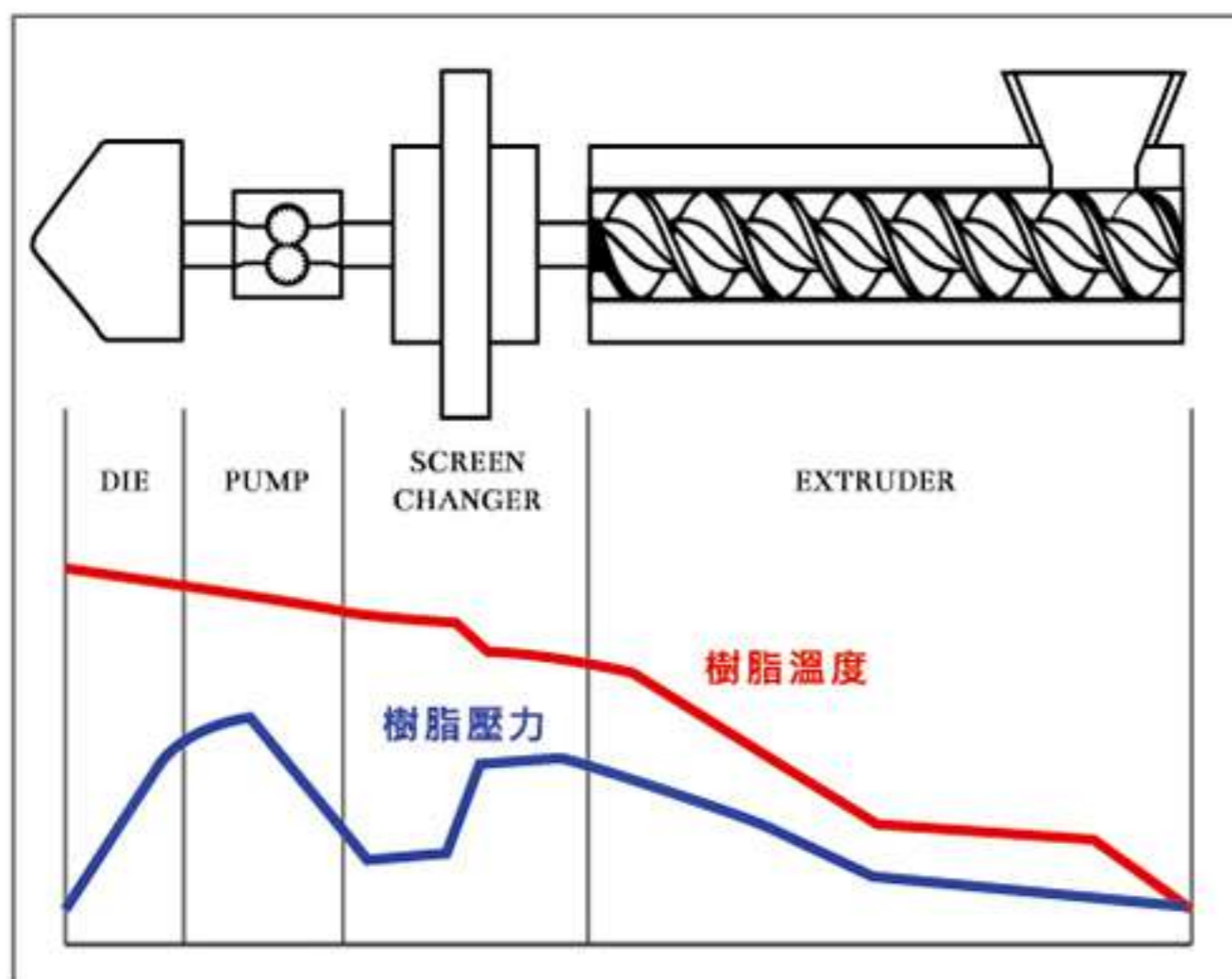

過濾網擺設在齒輪泵前/後面時，樹脂溫度及壓力的變化

## 節能30%以上

過濾網擺設在齒輪泵前面時，在過濾過程中壓力逐漸上升。此時，押出機需提高旋轉轉速才能獲得所需的排出壓力，而產生許多能源的消耗，也造成額外的熱量產生，樹脂溫度隨之提高，同時樹脂黏度下降而造成生產問題。因此，GMA將過濾網擺設在齒輪泵後面，由齒輪泵效能來提供足夠排出壓力，進而增加生產產量，並節省30%以上的能源消耗。

## Over 30% Energy Saving

When the filter is placed in front of the gear pump, the pressure gradually rises during the filtration process. At this time, the extruder needs to increase the rotation speed to obtain the required discharge pressure, which produces a lot of energy consumption, also causes additional heat generation, the resin temperature increases, and the resin the viscosity decreases and causes production problems. Therefore, GMA places the filter behind the gear pump, providing sufficient discharge from the gear pump performance. Pressure, which in turn increases production and saves more than 30% of energy consumption.

## 售後服務 After Service

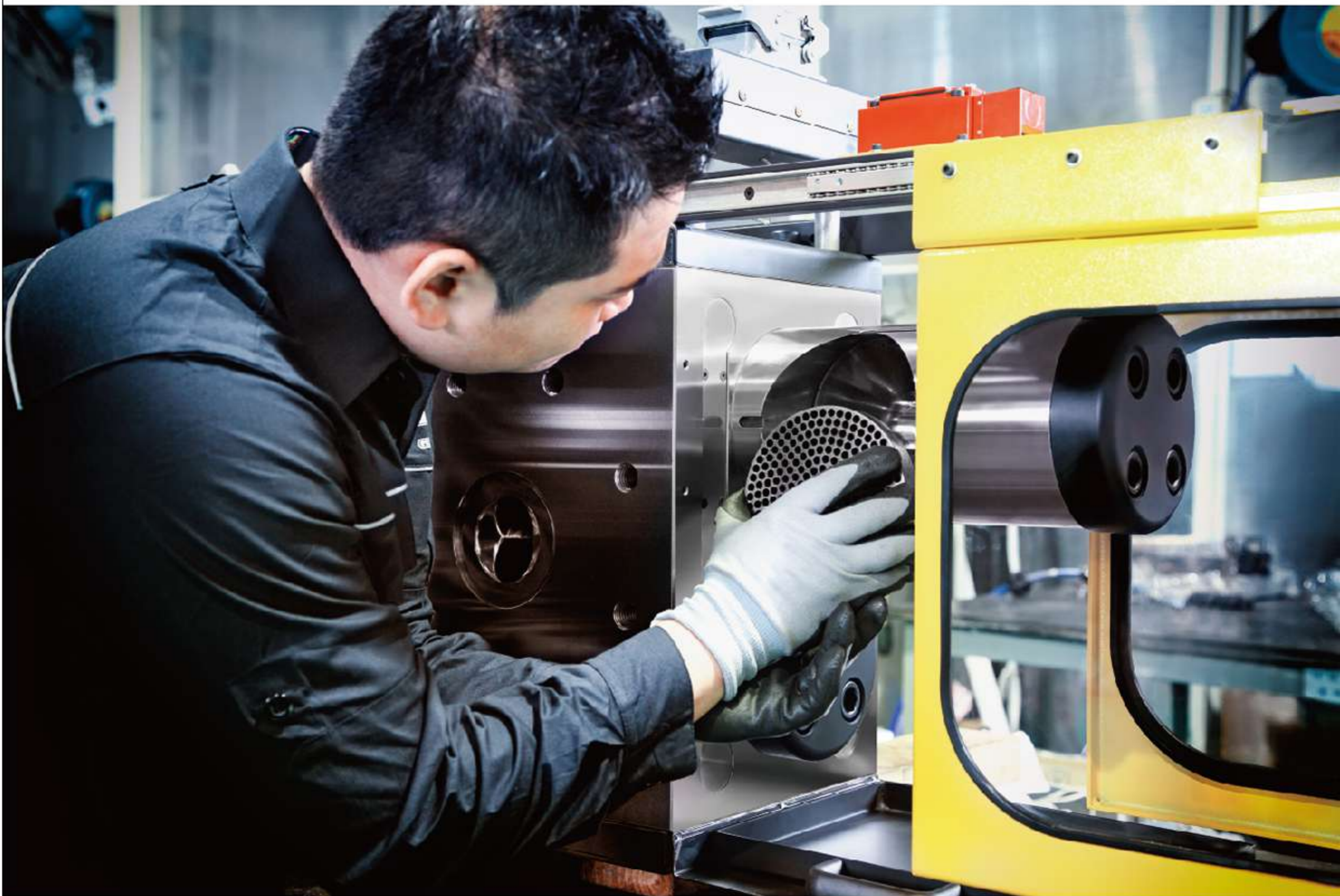

### 售後服務

政鈺機械以完整的加工設備、優秀的專業團隊做後盾，產品的設計、加工、組裝以及品檢，所有製程皆在本廠完成，除了產品的銷售外，我們亦提供最完整及最確實的全球性售後服務。服務內容包括產線規劃、設備安裝、機械調試、維修保養、零件供應及各項的技術諮詢與服務等。我們擁有經驗豐富及服務最熱忱的專業技術團隊，隨時為客戶提供無微不至的技術支援與服務。政鈺機械提供最高品質的機械設備給我們的客戶，並為我們的客戶群帶來最大的生產利益與最高的滿意度。

### After Service

GMA Machinery is backed by complete processing equipment and excellent professional team. The design, processing, assembly and quality inspection of the products are all completed in the factory. In addition to the sales of the products, we also provide the most complete and most accurate. Global after-sales service. Services include production line planning, equipment installation, mechanical commissioning, maintenance, parts supply and various technical consulting and services. We have experienced and most dedicated professional technical team, ready to provide customers with meticulous technical support and services. GMA Machinery provides the highest quality machinery and equipment to our customers and brings maximum production benefits and highest satisfaction to our customer base.

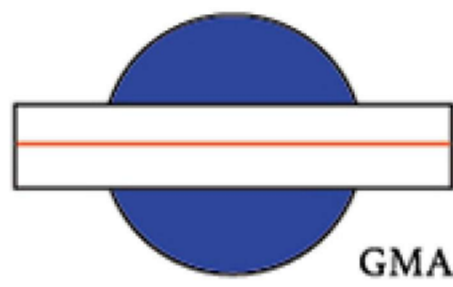

**政鈺機械股份有限公司**  
GMA MACHINERY ENTERPRISE CO., LTD.



 43547台中市梧棲區永興路二段362巷28號 | No.28 Lane 362, Sec. 2, Yung Hsing Rd., Wu Chi Dist., Taichung, Taiwan, R.O.C

 +886-4-26303228

 [info@gma.com.tw](mailto:info@gma.com.tw)

 +886-4-26303208

 [www.gmatw.com](http://www.gmatw.com)