

政鈺機械股份有限公司  
GMA MACHINERY ENTERPRISE CO., LTD.

# SHEET DIE

## 板材模具系列



客製化  
CUSTOMIZATION



模流分析  
ANALYSIS



優良品保  
QUALITY



專業維修  
MAINTENANCE

## 板材押出模具系列

### Sheet Extrusion Die

政鈺機械研發的板材系列模具，能滿足各種不同規格的單層與多層板材生產需要，並且可依客戶不同的需求條件，提供特殊多流道系統、光學級專用精密厚薄控制系統、自動控制系統、模唇替換調整系統、快速大幅模唇開口調整系統以及免停機厚度調整等選配，專業貼心的客製化服務，精準有效協助客戶提升產能，降低耗損。

GMA design and develop the sheet extrusion die with custom manifold design specifically for your production requirement. The multi-manifold design, automatic lip adjustment (thermo-bolts) can be selected as optional, interchangeable die lip for lip gap adjustment, quick lip gap adjustment system, and width adjustment system to best serve your need, further, to help reduce material waste.

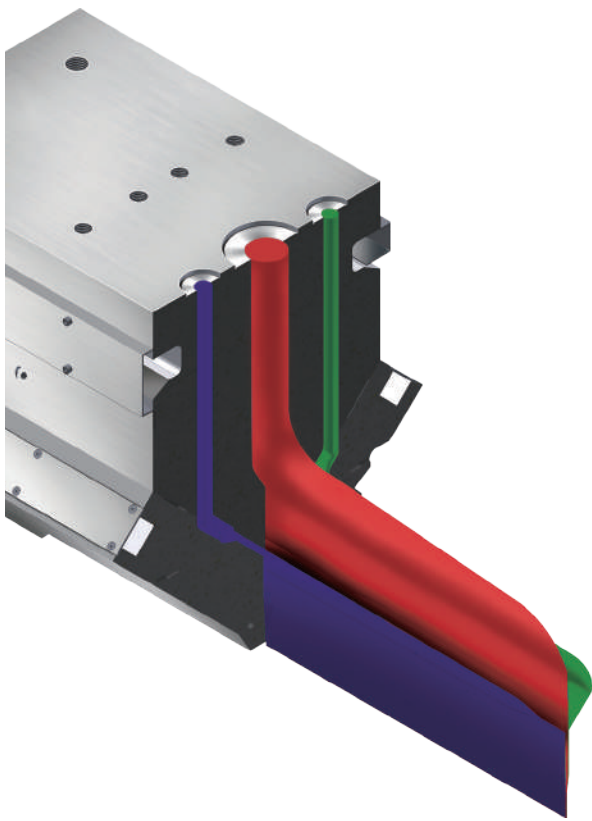
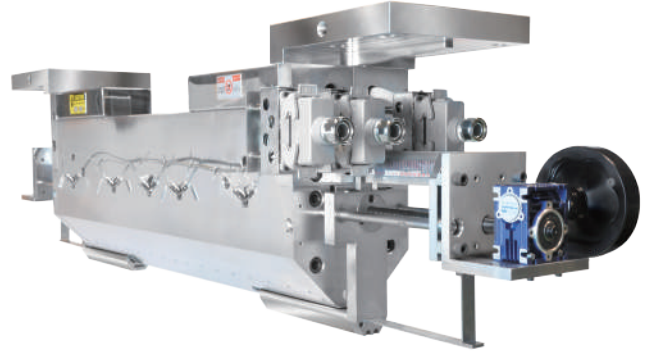

### 特殊多流道系統

#### Multi-manifold Die

透過三十年研發數據資料庫分析，無論是單一生產原料配方或是不同塑料的多層配置，搭配專業電腦CAE模擬程式，分析並建立不同塑料在流道內的流動性與流速變化模型，從模具單一流道、雙流道、三流道、五流道的設計，都能夠達到塑料流速平均，製品厚薄均勻效果。  
(單一流道模具若需生產多層製品，須搭配分配器)

GMA design the manifold according to 30 years of experience plus data base analysis. Moreover, the data will be plug into the CAE simulation software to showcase the flow characteristics.(Work with distributor/feedblock for the making of multi-layer configuration.)

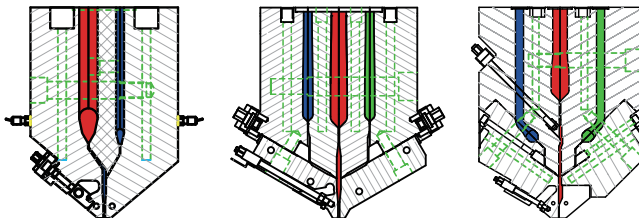

- 可選擇二層複合、三層複合、五層複合的設計
- 獨立幾何流道設計，提供最佳層與層複合介面
- 黏度差異大、流速差異大，可搭配流量調節閥設計
- 層與層之間塑料溫差大仍可完美結合的特殊隔熱設計
- 每轉0.25mm調整量的調整螺絲，是用厚薄差要求更嚴苛的產品

- Two-layer, three-layer, and five-layer multi-manifold design.
- Independent geometry manifold design provides the best co-extrusion interface.
- Viscosity difference, flow rate difference, can be used with flow control valve design.
- Thermal insulation design for big range resin temperature difference between layers is still perfectly integrated.
- 0.25mm adjustment screw per turn, apply to more severe product thickness requirements.

## 光學級專用精密厚薄控制系統

### High Precision Thickness Control System

採用高精度差速螺絲調整(0.25mm/rev)，可協助生產過程中操作細微厚薄調整控制，穩定度高，提高光學板良率。

With high precision differential screw(0.25mm/rev), the operator is capable of doing the very fine tuning during the production.

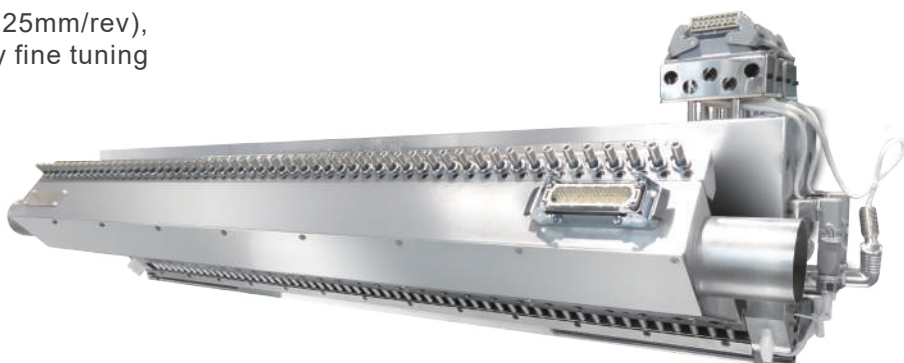

## 自動控制器系統

### Automatic Control System

模具加裝自動控制螺栓，將模具由原先手動調整厚薄升級為自動調整厚薄，透過測厚儀監測與連線控制，能夠協助在長時間的連續生產過程中及時精準控制製品的厚薄，減少不良品比率，節省調整工時，大幅提升製品品質。

Once the die is equipped with our automatic control system, the thermo bolts will synchronize with the thickness gauging system. The automatic system will do the fine tuning of the die gap. It will help to reduce the tuning time and defect loss greatly.especially for long time production control.

## 模唇調整 Lip Adjustment

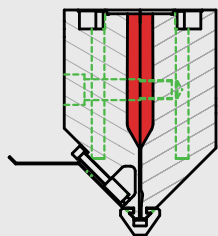

只壓不拉模唇調整螺絲  
Push only

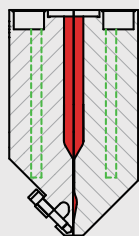

一壓一拉模唇調整螺絲  
Push & Pull

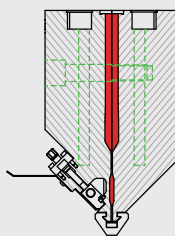

差速模唇調整螺絲  
Differential

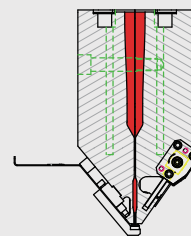

快速大幅模唇調整螺絲  
Quick lip gap adjustment

- 每轉1.25mm調整量
- 螺絲調整範圍2.0mm
- 適用於廣泛板類產線
- 可搭配外塞機構生產不同幅寬的產品
- 建議塞料寬不超過模寬1/3

- 1.25mm per rotation adjustment.
- Screw spacing 2.0mm.
- Apt for most sheet production lines.
- External deckle system for different width products.
- Deckle width should be within 1/3 slot width.

- 每轉0.5mm調整量
- 螺絲間距25mm
- 適用於多數板材生產線
- 可搭配外塞機構生產不同幅寬的產品
- 特定情況可選用內塞機構

- 0.5mm per rotation adjustment.
- Screw pitch 25mm.
- Apt for most sheet production lines.
- External deckle system for different width products.
- Internal deckle system available for specific spec..

- 調整範圍±2mm
- 可於產線生產中快速調整模唇開口，節省塑料浪費
- 唇口特殊拋光研磨製程
- 適用於多種厚度規格光學版製品
- 模寬在2500mm以內適用

- Quick gap range ±2mm.
- Lip gap adjustable during production to save resin.
- Special lip polishing process.
- Apt for optical sheet of variety of thickness.
- Die width within 2500mm recommended.

## 發泡模具

### Foam Sheet Dies

魚尾型流道設計，塑料可被均勻地展開，可減少熱敏感性塑料在押出過程中的裂解，上模唇可調、下模唇可更換、垂直流量調節閥裝置，可滿足不同塑料、不同厚度的製品需求，特殊模唇溫度控制裝置，可確保複合生產不同發泡製品，達到製品板段切面密度均勻，版面平整光滑無機械紋，共擠表層分配均勻，不易焦料。

厚度規格: 3-35mm

Special coat-hanger type manifold design reduce neat sensitive polymer cracking in the extrusion process. Suitable for foam sheets of different polymers and thicknesses Adjustable upper die lips, replaceable lower lip, vertical flow restrict bar. Special die lip temperature control design. Enable making of different foaming rate in coex production. Glossy and smooth surface of sheet.

Theickness :3-35mm

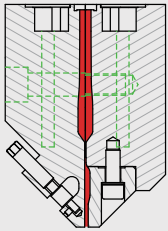
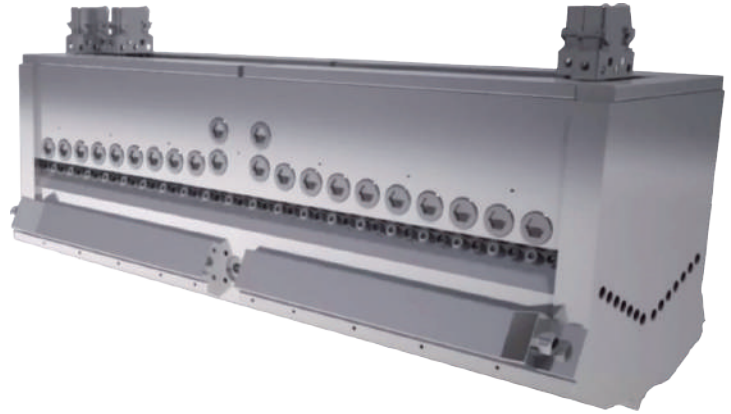

替換式模唇

Interchangeable die lip

- 可搭配各式調整螺絲
- 適用於多種厚度規格板材製品
- 更換模唇開口可生產厚薄範圍較大產品

All kinds of adjustment screws.  
Apt for variety of thick sheet products.  
Interchange die lip for big range thickness of sheet products.

### 節流閥 Restrict Bar

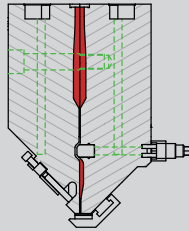

差速螺絲流量調整閥

Differential screw restrict bar

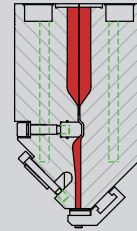

一壓一拉流量調整閥

One push & one pull screw restrict bar

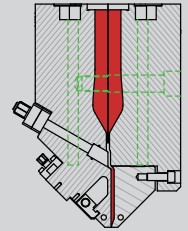

單一螺絲可壓可拉流量調整閥

One screw with push & pull restrict bar

- 適用厚板模具，針對大產量，原料流速差異大，回收塑料使用
- 不適用於熱敏感性高的塑料

• For thick sheet products, especially for those high output, different flow speed and regrind resin.  
• Not suitable for thermo-sensitive resin.

## 模唇替換調整系統

### Interchangeable Die Lip

針對生產板材厚度範圍超過 $\pm 2\text{mm}$ 以上的客戶，改以模唇替換調整方式，以上模唇做為調整開口基準，配合可替換下模唇，讓模唇開口調整範圍可達 $50\text{mm}$ 。  
(本系統需在停機狀態下進行模唇替換)

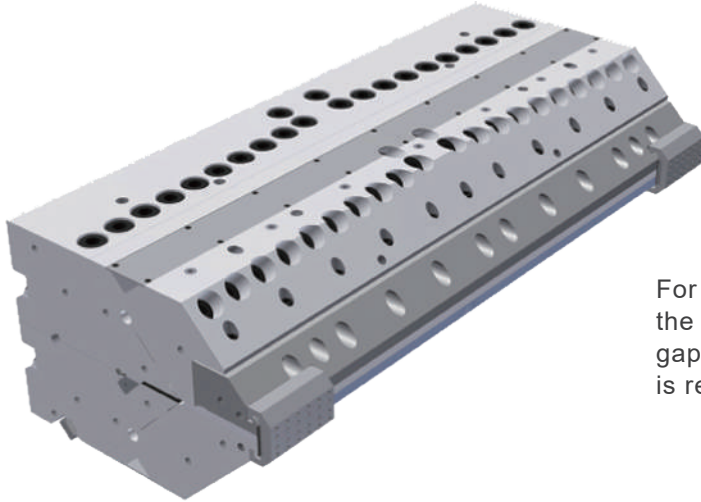
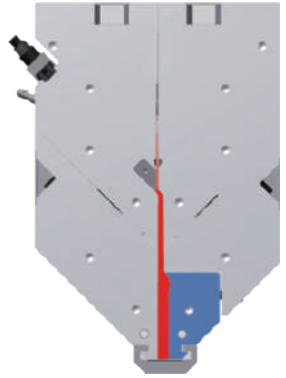

For customer who need greater lip gap range, ( $>\pm 2\text{mm}$ ), the replaceable die lip system can be implemented. Lip gap adjustment range can reach  $50\text{mm}$  when the lower lip is replaced. (Production needs to stop for replacement.)

## 快速大幅模唇開口調整系統

### Quick Lip Gap Adjustment

在生產過程中無須停機，可根據生產製品厚度變化，直接調整模唇開口，開口調整幅度可達 $\pm 2\text{mm}$ 。可縮短製程工時，提升產線效能。

The die lip can be adjusted within  $\pm 2\text{mm}$  during running production for increasing production efficiency and saving resin waste

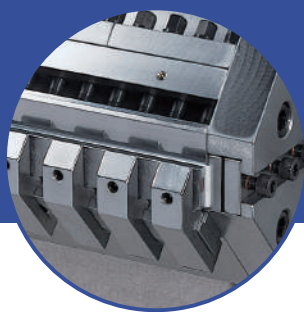
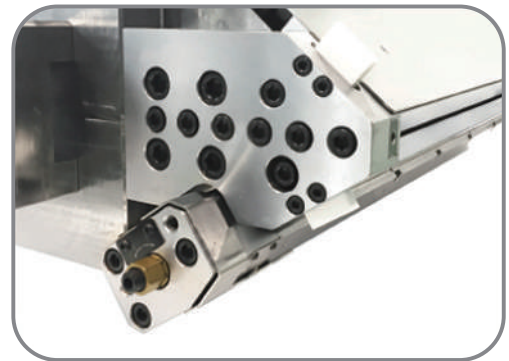

◀ 積木式外塞  
L-rail

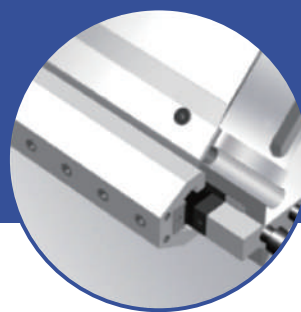

◀ 凹槽式外塞  
U-rail



## 免停機寬度調整

### Non-stop Width Adjustment

生產過程無須停機，可根據生產製品寬幅變化，直接調整模具出料寬幅，大幅降低調整時間，減少原料耗損。

For diversity of end-product, GMA offer various devices for quick and convenient width adjustment during running production.

## 拆模機台 Die Carts

- 專用模具支撐架，方便模具從機台上移動至支撐架，避免拆卸模具時損傷模唇。
  - 運動支撐架輕鬆定位，模具拆開清潔完畢可以直接組裝，無須重新校正位置。
  - 配置簡易操作驅動系統，可迅速拆開模具本體，節省人力以及時間。
- Easy to move extrusion die from machine to die carts to avoid die damage.
  - Die support positioning design for easy assemble and disassemble die body when channel cleaning.
  - Quick open the die body to save manpower and time by the drive system.

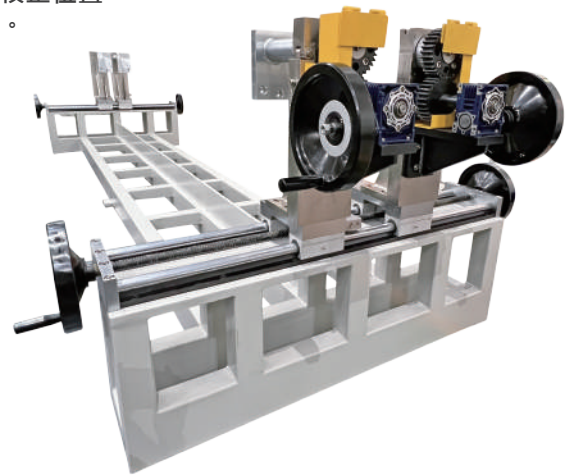

## 高精度加工製程 High Precision Machining

透過超精密研磨、拋光等加工，使流道表面不易沾黏，造成流痕，增加良率，提高光學板製品光滑與平坦。

The optical sheet is flat and smooth due to the high precision grinding, polishing, and machining on the extrusion dies.

## 適用原料 Suitable Polymer

PC、PE、PP、EVA、MS、PVB、PVC、TPU、ABS、PLA、GPPS、HIPS、APET、GPET、PMMA、PI

## 運用領域 Application

可廣泛應用於文具用品、食器、建築、汽車、工業、航空、各式光學薄板(導光板、擴散板、偏光板)及3C產業(電腦、電視、手機、背光模組)等領域。

Stationery, food-grade container, constructions, automobile, industrial, aviation industry, Optoelectronics (light guide sheet, diffusion plate, polarizer) Backlight module, and panel display.

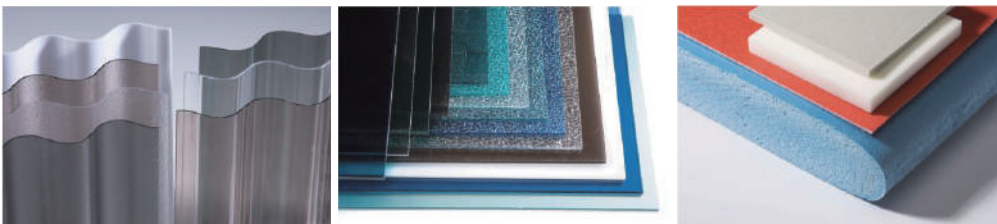

|                               |                          |              |
|-------------------------------|--------------------------|--------------|
| 產品規格<br>Product Specification | 產品寬度範圍 Product Width     | 50~7000 mm   |
|                               | 產品厚度範圍 Product Thickness | 0.15~50 mm   |
|                               | 適用押出量 Extrusion Capacity | 1~3500 kg/hr |

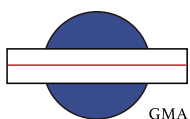

**GMA** 政鈺機械股份有限公司  
GMA MACHINERY ENTERPRISE CO., LTD.



43547 台中市梧棲區永興路二段362巷28號 | No.28 Lane 362, Sec. 2, Yung Hsing Rd., Wu Chi Dist., Taichung

+886-4-26303228

info@gma.com.tw

+886-4-26303208

www.gmatw.com